

JU9112 BALCÃO 70

Instruções de montagem Assembly Instructions / Instrucciones de Montaje



DELMARCO



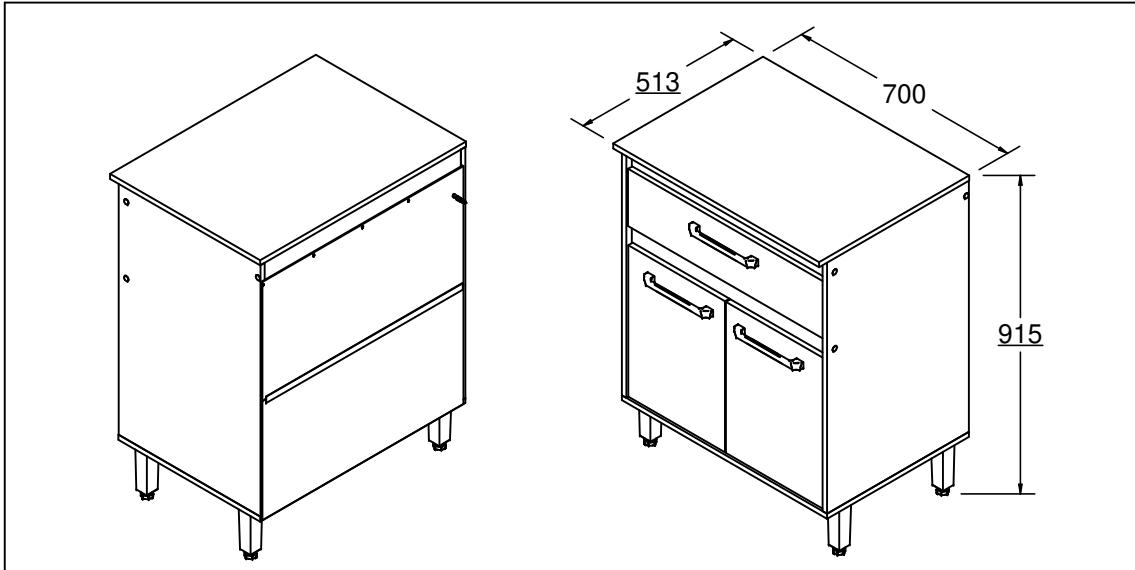



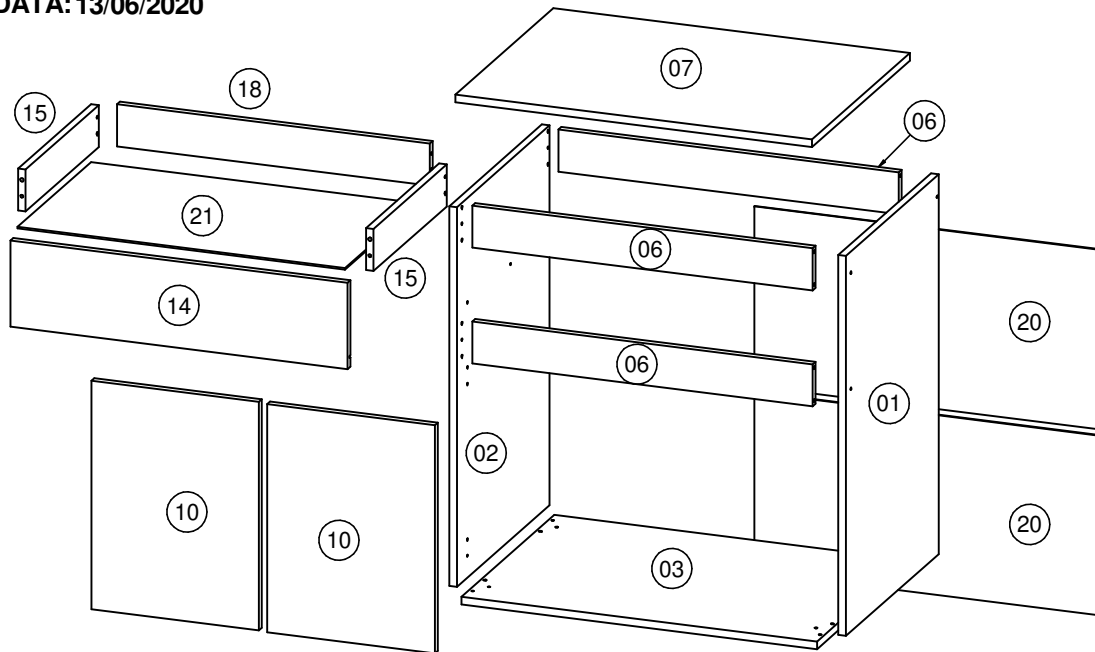





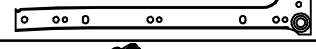





1

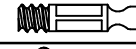

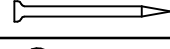
REV.: 00
DATA: 13/06/2020

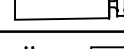
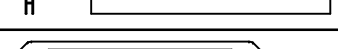

LISTA DE PEÇAS / LISTA DE PIEZAS / PARTS LIST			
COD	DESCRIÇÃO / DESCRIPCIÓN / DESCRIPTION	DIM / DIM / DIM	QTD
01	LATERAL DIREITA/ LATERAL DERECHO/ RIGHT SIDE	740 x 482 x 15	1
02	LATERAL ESQUERDA/ LATERAL IZQUIERDA/ LEFT SIDE	740 x 482 x 15	1
03	BASE/ BASE/ BASE	698 x 482 x 15	1
06	TRAVESSA/ TRAVESAÑO/ CROSSPIECE	668 x 82 x 15	3
07	TAMPO/ TAPA/ TOP	700 x 510 x 15	1
10	PORTA/ PUERTA/ DOOR	445 x 329 x 15	2
14	FRENTE GAVETA/ FRENTE DEL CAJÓN/ FRONT OF THE DRAWER	168 x 662 x 15	1
15	LATERAL GAVETA/ LAT CAJÓN/ DRAWER SIDE	380 x 82 x 15	2
18	COSTA GAVETA/ TRASERA DEL CAJÓN/ BACK OF THE DRAWER	614 x 82 x 15	1
20	COSTA/ FONDO/ BACK	350 x 683 x 3	2
21	FUNDO GAVETA/ FONDO DEL CAJÓN/ BOTTOM OF THE DRAWER	643 x 383 x 3	1

LISTA DE FERRAGENS / LISTA DE ACCESORIOS / HARDWARE LIST			
COD	DESCRIÇÃO / DESCRIPCIÓN / DESCRIPTION		QTD
A	 CAVILHA Ø6X30 CLAVIJA Ø6X30 WOOD DOWEL Ø6X30		20
B	 PARAFUSO CF 4,5X50 TORNILLO CF 4,5X50 SCREW CF 4,5X50		38
C	 PARAFUSO CC 3,5X40 TORNILLO CC 3,5X40 SCREW CC 3,5X40		12
CR	 CORREDIÇA CORREDEIRA SLIDE		1
DA	 DOBRADIÇA BISAGRA HINGE		4
E	 PARAFUSO CF 3,5X30 TORNILLO CF 3,5X30 SCREW CF 3,5X30		6
F	 PARAFUSO CF 4,5X50 TORNILLO CF 4,5X50 SCREW CF 4,5X50		5
G	 SUPORTE FIXAÇÃO SOPORTE DE FIJACION FIXING SUPPORT		1
H	 PROTEÇÃO SUP CANTONEIRA PROTECCIÓN ANGLE BRACKET		1
I	 BUCHA PLÁSTICA CASQUILLO BUSHING		1
J	 TAMBOR MINIFIX TUERGA MINIFIX MINIFIX DRUM		2
K	 PARAFUSO MINIFIX TORNILLO MINIFIX SCREW MINIFIX		2
L	 CANTONEIRA 18X18 ESQUINERO 18X18 CORNER 18X18		4
M	 PREGO 10X10 CLAVO 10X10 NAIL		20
N	 ADESIVO TAPA FURO ADHESIVO STICKER		6
PE	 PÉ PIE FOOT		4
PF	 PERFIL H PERFIL H PROFILE H		1
PX	 PUXADOR TIRADOR HANDLE		3
V	 COLA PEGAMENTO GLUE		1
Y	 PARAFUSO CC 3,5X30 TORNILLO CC 3,5X30 SCREW CC 3,5X30		3
Z	 BATEANTE SILICONE SILICONE STOP TAPON SILICONA		2

**"IMPORTANTE
LER COM
ATENÇÃO
E GUARDAR
PARA EVENTUAIS
CONSULTAS".**
"IMPORTANTE LEER CON
ATENCIÓN Y GUARDAR PARA
EVENTUALES CONSULTAS".
"IMPORTANT TO READ
CAREFULLY AND SAVE FOR
ANY QUERIES".



FERRAMENTAS NECESSÁRIAS:
HERRAMIENTAS NECESSARIAS:
NECESSARY TOOLS:

