

Obs: Usar caixa da embalagem para forrar o chão na hora da montagem
 Note: Use the packing box to cover the floor at the time of assembly
 Nota: Utilice la caja de embalaje para cubrir el suelo en el momento del montaje

Para pedidos de Assistência Técnica agrupar a Referência da Peça com N° da Cor. Ex.: 1385A0.001.250 (Painel na cor Branco Tx)

Cód.	Referência	Cor	Pegás	Qt.	Medidas	M.P.	Piece	Pieza
01	1385A0.001	250	Panel	2	1200x330x15	MDP	Panel	Panel
02	1385A0.002	250	Panel central	1	1200x240x15	MDP	Central panel	Panel central
03	1385A0.003	250	Tampo	1	1200x300x15	MDP	Cover	Cubierta
04	1385A0.004	250	Base	1	1200x300x15	MDP	Base	Base
05	1385A0.005	250	Lateral	2	155x298x15	MDP	Side	Lado
06	1385A0.006	250	Divisão	1	155x250x15	MDP	Division	División
07	1385A0.007	99	Travessa lateral	2	800x80x15	MDP	Travessa side	Travessaño lado
08	1385A0.008	99	Travessa fixação inf	1	595x80x15	MDP	Travessa fixation inf	Travessaño fijación inf
09	1385A0.009	99	Travessa fixação sup	1	595x80x15	MDP	Travessa fixation sup	Travessaño fijación sup
10	1385A0.010	250	Fundo	2	300x200x15	MDP	Bottom	Fondo

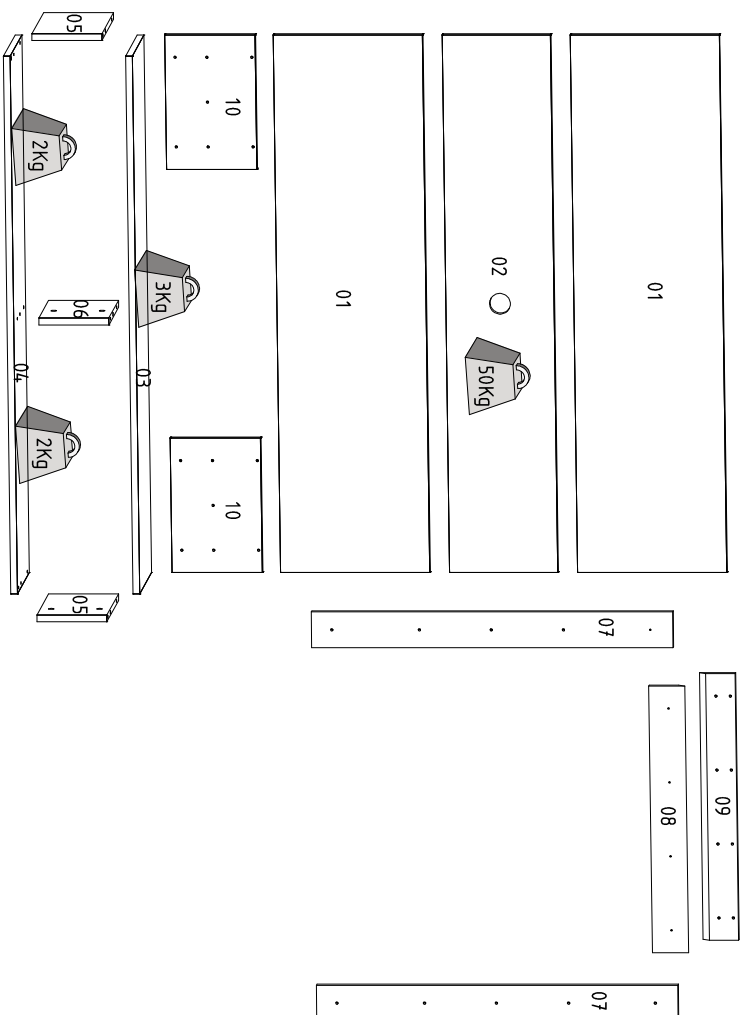

A	B	C	D	E	F	G	H
Parafuso 5,0x50 cod. 812	Parafuso 4,0x50 cod. 782	Parafuso 4,0x25 cod. 780	Parafuso 3,5x14 cod. 776	Pino p. girofix cod. 162	Gavilha 6x30 cod. 969	Bucha fixação 08 cod. 130	Santa de cola cod. 166
10x	08x	18x	24x	06x	12x	10x	01x
01x	06x	06x	12x				
Passa fio 40mm	Chapa refa 4 furos cod. 146	Tambor 012 cod. 183	Tapa furo				

Cuidados com a limpeza do móvel:

Não molhar o móvel e não expor em lugar úmido.

Do not wet the furniture and do not expose it in a humid place.

No moje los muebles y no los esponga en un lugar húmedo.

Não expor o móvel próximo de fontes de calor.

Do not expose this furniture close to sources of heat.

No exponga el mueble cerca a fuentes de calor.

Limpar apenas com pano limpo e levemente úmido

Clean the product using only a clean and slightly damp cloth.

Limpiar solo con un paño limpio y ligeramente húmedo

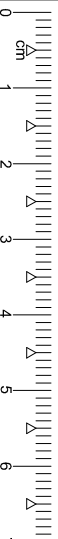

Meça seu acessório aqui

ETAPAS DA MONTAGEM / STAGES OF THE ASSEMBLY / ETAPAS DE LA ASAMBLEA

Para uma montagem perfeita do produto, siga a sequência:

For a perfect product assembly, follow its sequence / Para un montaje perfecto del producto, sigue la secuencia.

Passo 01

- F 06x
- F 12x
- 6x30
- 06x
- L 06x

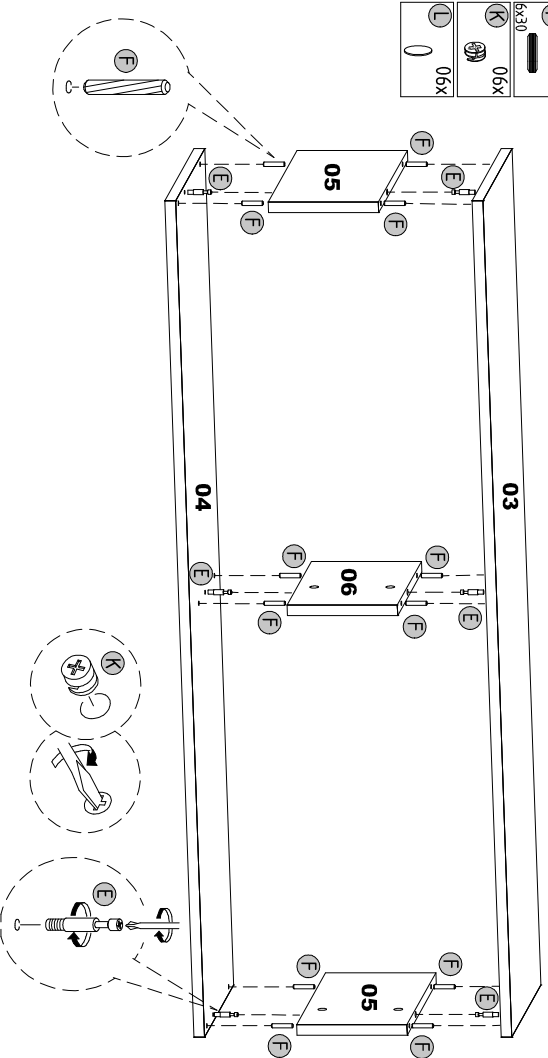

Passo 02

- B 08x
- 4,0x50

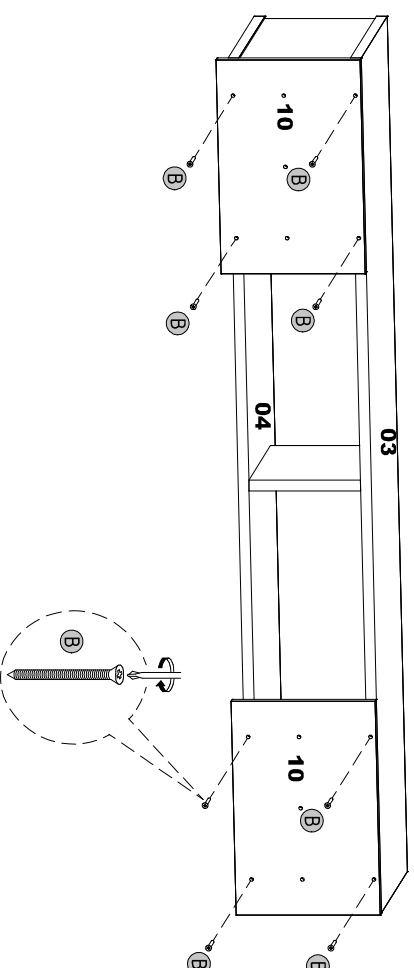

Passo 03

- L 10x
- 4,0x25

Vista traseira

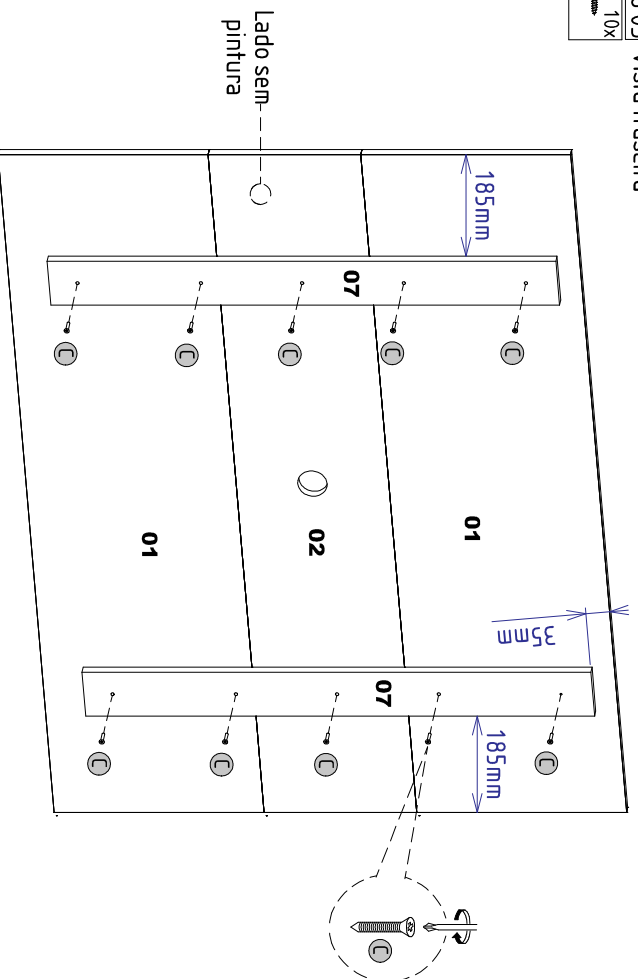

Passo 04

- C 08x
- 4,0x25
- L 24x
- 3,5x14
- H 01x
- 06x

Vista traseira

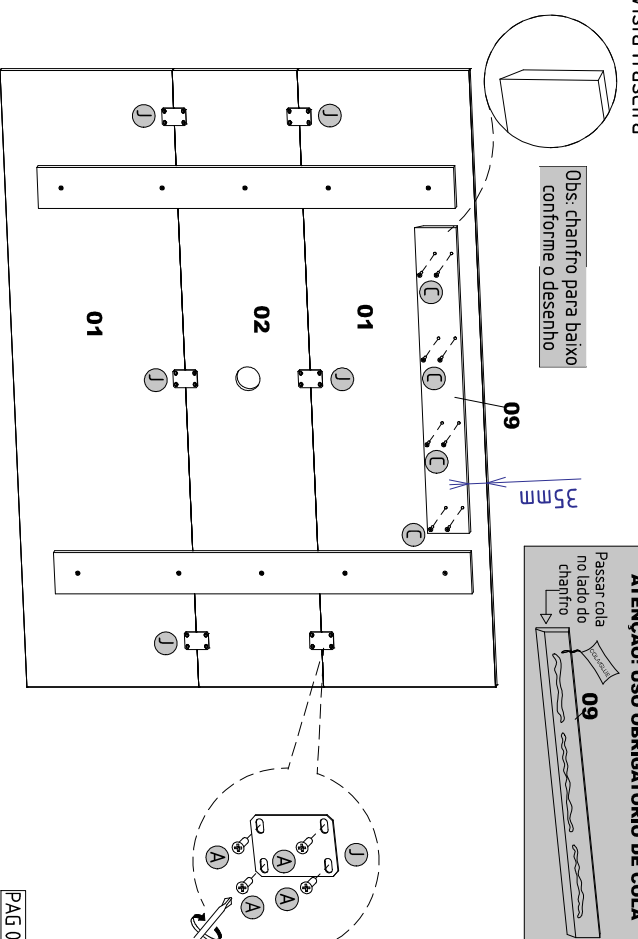

ATENÇÃO: USO OBRIGATORIO DE COLA

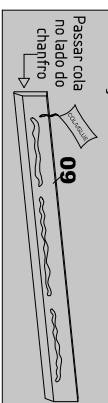

Lado sem pintura

ETAPAS DA MONTAGEM / STAGES OF THE ASSEMBLY / ETAPAS DE LA ASAMBLEA

Para uma montagem perfeita do produto, siga a sequência:

For a perfect product assembly, follow its sequence / Para un montaje perfecto del producto, sigue la secuencia.

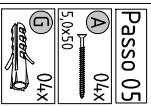

Sugestão de altura:
do piso ao meio do furo
da peça 08

1450

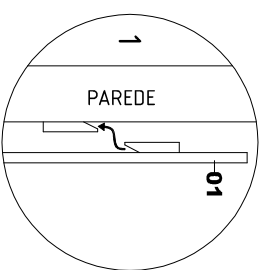
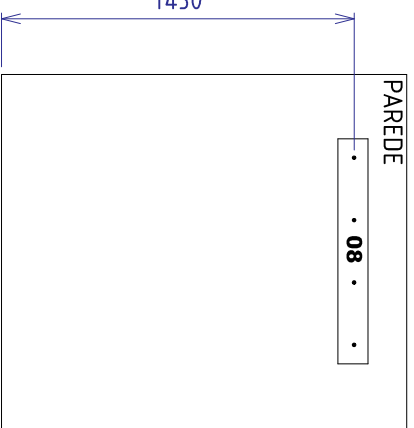

Encaixar a travessa do
painel na travessa da parede
seguinto as instruções.

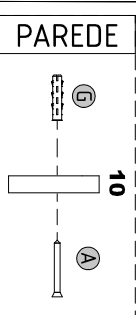
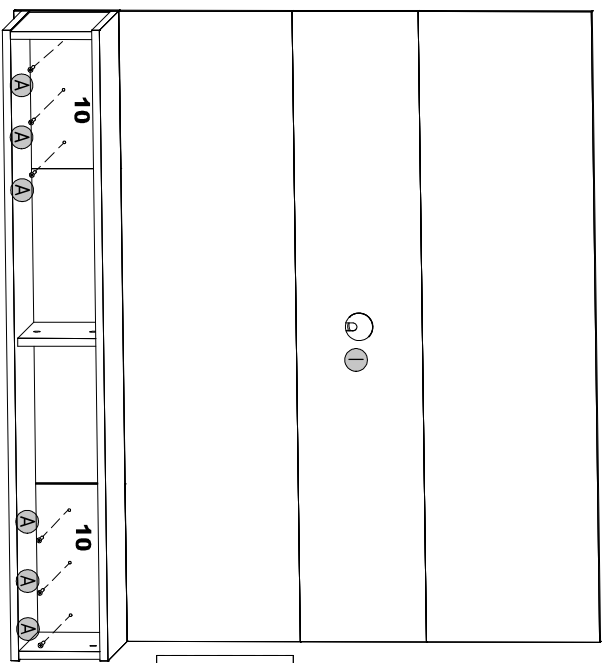
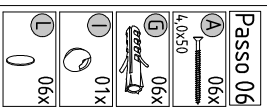
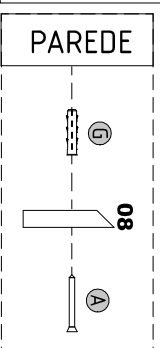

Medida Final

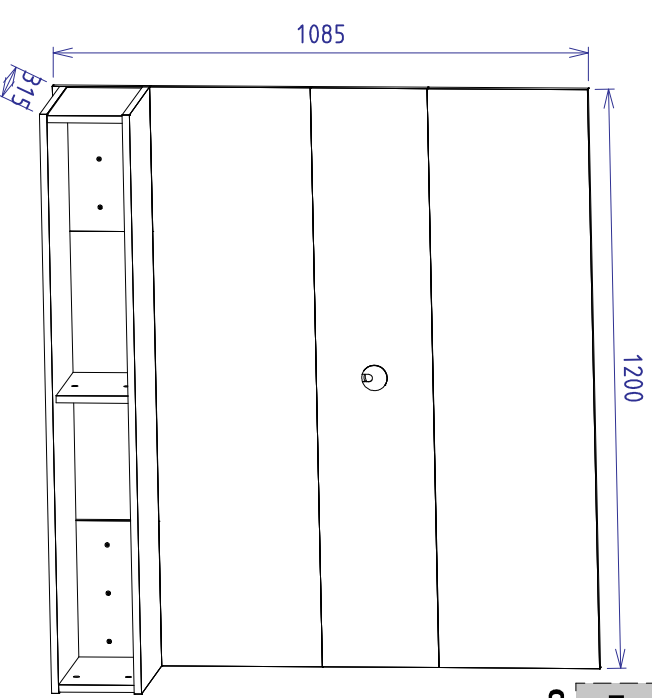

ATENÇÃO:
Fixar TV somente
no painel.
O painel comporta
TV de até 51"