

HENN

Aéreo O2 Portas de vidro 800mm Connect | Aéreo O2 Puertas de cristal 800mm Connect |
Aerial O2 Glass doors 800mm Connect

Referência/Cor

c C55-23 Duna

c C55-42 Fendi

Requisitos para montagem

Requisitos para la montaje

Assembly Requirements

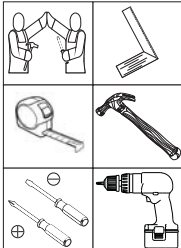

Imagens meramente ilustrativas
Imágenes meramente ilustrativas
Images for illustration only

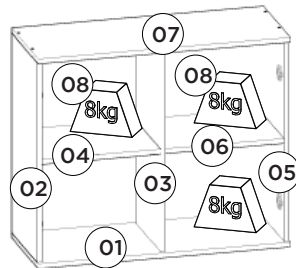
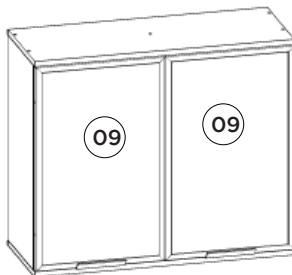

Pesos máximos recomendados com carga distribuída
Peso máximo recomendado con la carga distribuída
Recommended maximum weight with distributed load.

Lista de Peças | Lista de piezas | List of parts

Item	Caixa Caja Box	Qtd Ctd Qty	Descrição Descripción Description	Medidas (mm) Dimensiones (mm) Size (measurements) (mm)
01=07	1/1	01	Base tampo Base cubierta Base top	800x310x15
02=05	1/1	01	Lateral Direita Esquerda Lateral Derecha Izquierda Right Side Left	645x295x15
03	1/1	01	Divisão División Division	645x295x15
04=06	1/1	01	Prateleira Estante Shelf	376x295x15
05=02	1/1	01	Lateral Direita Esquerda Lateral Derecha Izquierda Right Side Left	645x295x15
06=04	1/1	01	Prateleira Estante Shelf	376x295x15
07=01	1/1	01	Base tampo Base cubierta Base top	800x310x15
08	1/1	02	Fundo Fondo Bottom	669x395x3
09	1/1	02	Porta de Vidro Reflecta Cristal de la puerta Reflecta Reflective Glass Door	639x394x20

Ferragens | Herrajes | Hardware

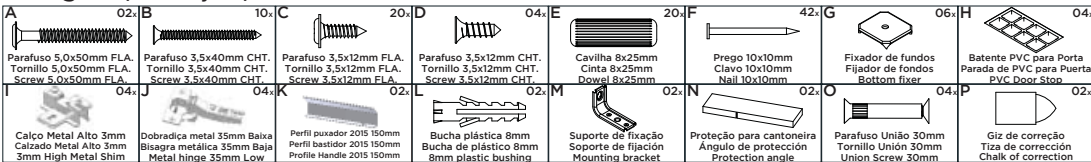

<p>O parafuso (O) deve ser usada somente quando este módulo for acoplado a outro módulo componível Henn.</p>	<p>RECOMENDAÇÃO</p> <p>Para fixar o móvel na parede usar o suporte de fixação (M), o parafuso 3,5x12mm FLA (C), a Bucha 8mm (L) e o parafuso 5,0x50mm FLA (A).</p>
<p>El tornillo (O) se debe utilizar sólo cuando el módulo está conectado a otro módulo componible Henn.</p>	<p>RECOMENDACIÓN</p> <p>Para conectar el móvil a la pared con el soporte (M), tornillo 3,5 x12mm FLA (C), el casquillo de 8 mm (L) y el 5,0 x50mm tornillo FLA (A).</p>
<p>The screw (O) should be used only when this module is attached to another Henn modular module.</p>	<p>RECOMMENDATION</p> <p>To fix the furniture to the wall use the fixing bracket (M), the 3.5x12mm FLA (C) screw, the 8mm bushing (L) and the 5.0x50mm screw (A).</p>

1º

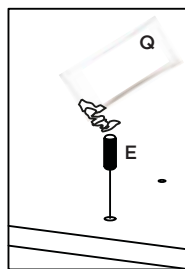
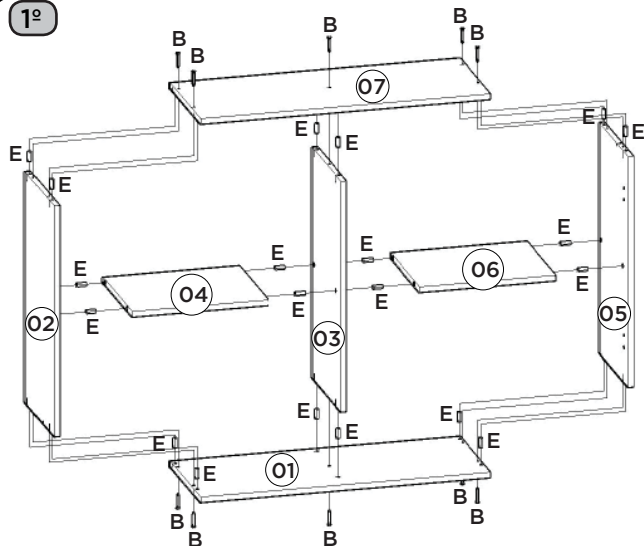

Utilizar o sachê de cola (Q) em todas as cavilhas (E) do produto.

Con el pegamento sobre (Q) en todos los pernos (E) del producto.

Use the glue sachet (Q) on all the pegs (E) of the product.

AVISO

Para limpeza de seu móvel, use uma flanela seca ou umedecida, e não utilize produtos químicos que possam danificar seu produto.

2º

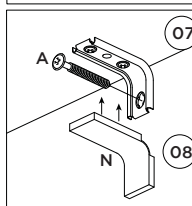
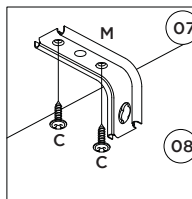
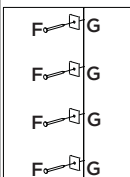
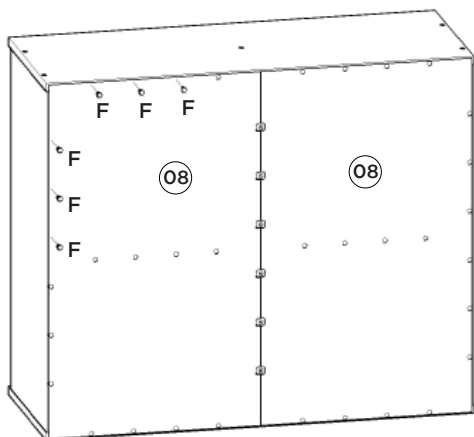

SISTEMA DE MONTAGEM

O sistema de montagem dos produtos funciona de acordo com a ordem crescente dos números indicados no desenho. Ex: 01, 02, 03, 04... até a conclusão da montagem.

ADVERTENCIA

Para limpieza de su móvil, use una flanela seca o húmeda, y no utilice productos químicos que puedan dañar su producto.

SISTEMA DE MONTAJE

El sistema de montaje de los productos funciona de acuerdo con el orden creciente de los números indicados en el dibujo. Ej.: 01, 02, 03, 04... hasta la conclusión del montaje.

3º

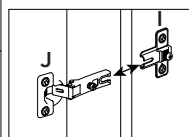
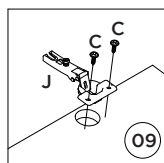
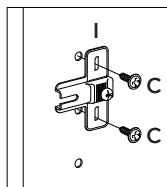
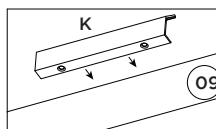
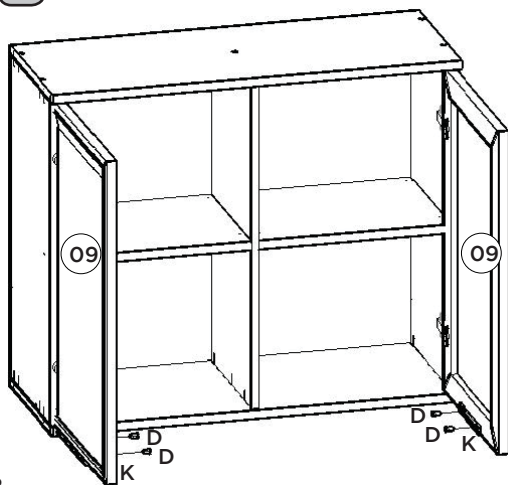

NOTICE

To clean your furniture, use a dry or wet cloth, and do not use chemicals that may damage your product.

ASSEMBLY SYSTEM

The products' assembly system works according to the increasing order of the indicated numbers. For example: 01, 02, 03, 04 ... to the end of the assembly.