

# MANUAL DE MONTAGEM

## INSTRUCCIONES DE MONTAJE

### ASSEMBLY INSTRUCTIONS

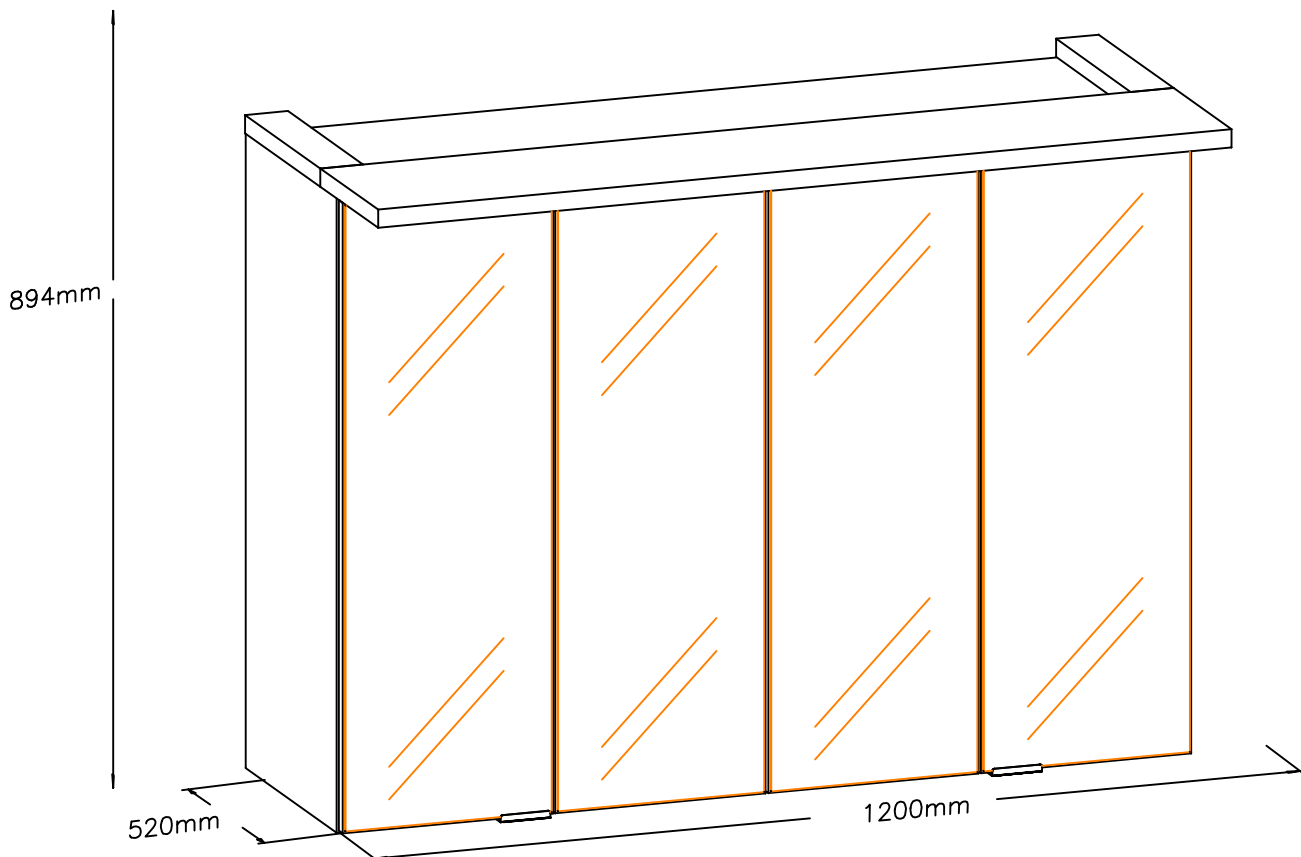

## ATENÇÃO / PRECAUCIÓN / ATTENTION:

- 1 – Ler atentamente todo o manual antes de iniciar a montagem do móvel.
- 2 – A montagem deve ser feita em uma superfície plana e limpa.
- 3 – Recomenda-se utilizar a embalagem do móvel para forrar e chão e assim não danificá-lo.
  - 1 – Lea cuidadosamente todo el manual antes de comenzar el montaje.
  - 2 – La instalación debe hacerse sobre una superficie plana y limpia.
  - 3 – Recomanda ser utilizado para empaquetar móvel a la línea y tierra y por lo tanto dañar ellos.
- 1 – Read the entire manual carefully before starting the furniture assembly.
- 2 – The assembly must be done on a flat and clean surface.
- 3 – It is recommended to use the packaging of the furniture to cover and floor and thus not to damage them.

## LIMPEZA E CONSERVAÇÃO / LIMPIEZA Y CONSERVACIÓN / CLEANLINESS AND CONSERVATION:

A limpeza do móvel deve ser feita com utilização de pano umedecido com água, podendo conter uma pequena quantidade de álcool. Não utilize produtos abrasivos.

La unidad de limpieza se debe realizar con el uso de paño humedecido con agua y puede contener una pequeña cantidad de alcohol. No utilice productos abrasivos.

The furniture should be cleaned with a cloth dampened with water and may contain a small amount of alcohol. Do not use abrasive products.

## GARANTIA / GARANTÍA / WARRANTY:

90 dias para defeitos de fabricação.

90 días a defectos de fabricación.

90 days for manufacturing defects.

## FERRAMENTAS NECESSÁRIAS / HERRAMIENTAS NECESARIAS / TOOLS REQUIRED:

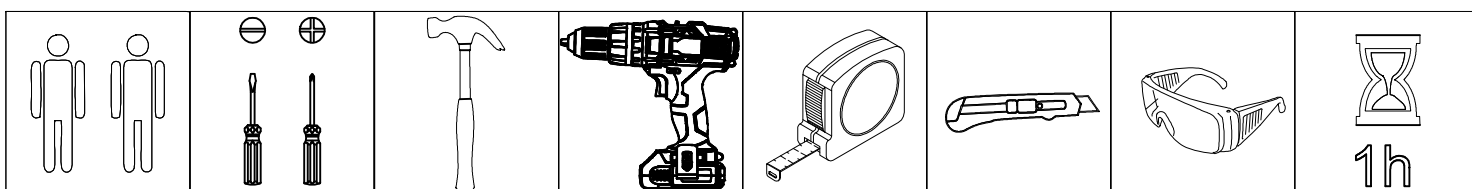

Acesse as dicas de  
montagem no Youtube

Accede a los consejos de  
montaje en Youtube.

Access the mounting tips on  
Youtube.









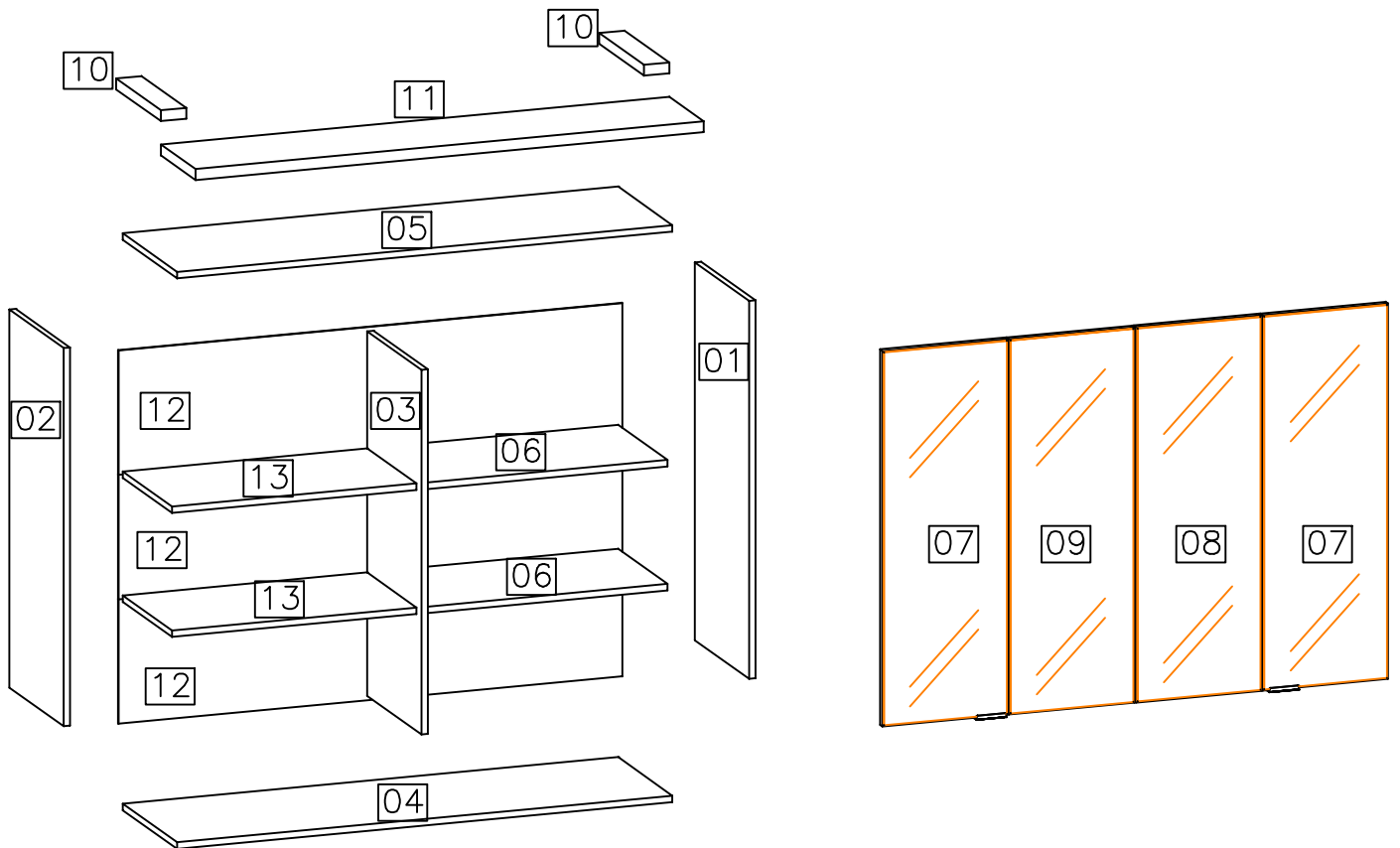



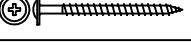
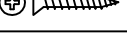



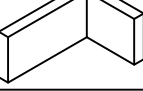
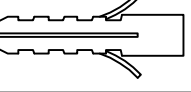



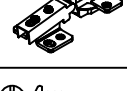

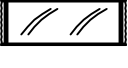
[www.youtube.com/MoveisKappesberg](http://www.youtube.com/MoveisKappesberg)

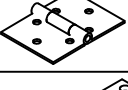

## Lista de peças / Lista de piezas / List of pieces

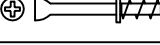
Código/ Código/ Code	Descrição	Descripción	Description	Quantidade/ Cantidad/ Amount	Comprimento/ Longitud/ Length (mm)	Largura/ Ancho/ Width (mm)	Espessura/ Espesor/ Thickness (mm)	Caixa/ Caja/ Box
01	Lateral direita	Lateral derecha	Right side	1	869	352	15	B
02	Lateral esquerda	Lateral izquierda	Left side	1	869	352	15	B
03	Divisória	División	Division	1	838	320	15	B
04	Base	Pieza de suelo	Base	1	1170	352	15	A
05	Chapéu	Pieza de techo	Top	1	1170	352	15	A
06	Prateleira direita	Estanterías derecha	Right Shelf	2	577	320	15	A
07	Porta com puxador	Puerta con asa	Door with handle	2	863	296	15	B
08	Porta dir. sem puxador	Puerta derecha sin asa	Right door without handle	1	863	296	15	B
09	Porta esq. sem puxador	Puerta izquierda sin asa	Left door without handle	1	863	296	15	B
10	Rodaforro lateral	Marco superior	Upper frame	2	290	60	25	A
11	Rodaforro frontal	Marco de frente	Front frame	1	1201	224	25	A
12	Costa	Pieza del fondo	Back panel	3	1190	286	3	A
13	Prateleira esquerda	Estanterías izquierda	Left Shelf	2	577	320	15	A

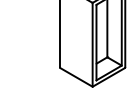
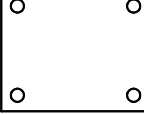

Ferragem / Herrajes / Hardware			
	Código/ Código/ Code	Descrição / Descripción / Description	Quan. / Cant. / Amou.
A	226	 Parafuso/ Tornillo/ Screw 4x40	20
B	4214	 Parafuso/ Tornillo/ Screw 3,5x14	52
C	50311	 Parafuso/ Tornillo/ Screw 5,0x65	6
D	491	 Parafuso/ Tornillo/ Screw 4x25	4
E	107	 Prego/Clavo/Nail 10x10	65
F	1802	 Cavilha/Tarugo/Peg 6x30mm	20
G	1925	 Cavilha/Tarugo/Peg 6x50mm	4
H	17024	 Suporte aéreo zb/Soporte de seguridad/Safety bracket	6
I	6959	 Capa para suporte branca/Cubierta de soporte/Support cover	6
J	529	 Bucha invasa/Adapter sleeve/ Manga del adaptador	6
K	58	 Etiqueta marca/Tag label "Kappesberg"	1
L	45054	 Puxador de chapa J/Asar/Handle Champagne	2
M	FR=51255 (Freijo)	 Tapa furo/Tapa del agujero/Tap hole 13mm	24
N	FR=51256 (Freijo)	 Tapa furo/Tapa del agujero/Tap hole 19mm	4
O	51322	 Dobradiça reta 35mm calço fixo com amortecedor/Bisagra /hinge	4
P	1828	 Parafuso/ Tornillo/ Screw 3,5x14	16
Q	41	 Cola branca em bisnaga/Cola blanca/White glue (10g)	1
R	40534	 Silicone/Silicona/ Selecone 10x10	6
S	51162	 Dobradiça lapela/Bisagra/ Hinge	4
T	51425	 Dobradiça reta/Bisagra/ Hinge 35mm camarão	2
U	51160	 Guia superior/Guía superior/Top guide sistema camarão	2
V	51429	 Trilho superior/Carril superior/Upper rail camarão 1170mm alumínio	1
W	1423	 Fixador de costa/Fijador de costa/Shore Fixer	25
X	30945	 Parafuso Minifix/ Tornillo/ Screw	4
Y	30950	 Tambor Minifix/Cilindro/Drum	4
Z	51538	 Vidro/Vidrio/Glass Bronze 85x290x3mm	4
AA	414	 Parafuso/ Tornillo/ Screw 4,0x35	7
AB	51840	 Batente/Parada/Stop 70mm	2
AC	1454	 União de metal/Unión del Metal/Metal Union	1
01 Saco grande para acessórios			
01 Saco pequeno para puxador			



