

MANUAL DE MONTAGEM

INSTRUCCIONES DE MONTAJE

ASSEMBLY INSTRUCTIONS

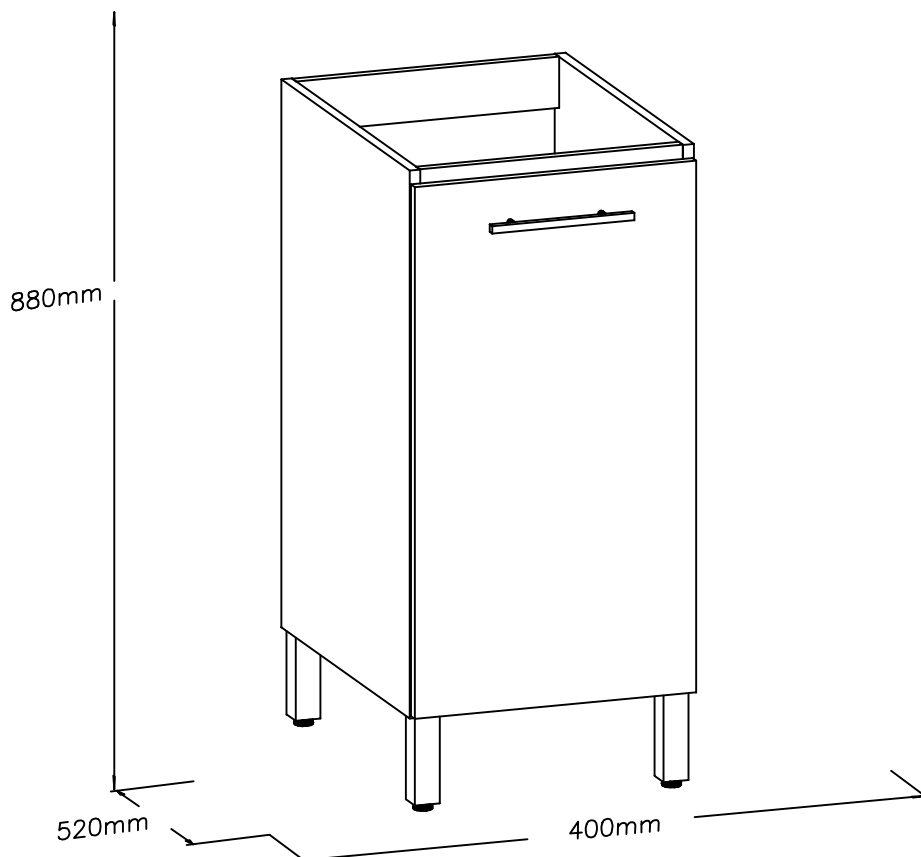

ATENÇÃO / PRECAUCIÓN / ATTENTION:

- 1 – Ler atentamente todo o manual antes de iniciar a montagem do móvel.
- 2 – A montagem deve ser feita em uma superfície plana e limpa.
- 3 – Recomenda-se utilizar a embalagem do móvel para forrar e chão e assim não danificá-lo.
 - 1 – Lea cuidadosamente todo el manual antes de comenzar el montaje.
 - 2 – La instalación debe hacerse sobre una superficie plana y limpia.
 - 3 – Recomanda ser utilizado para empaquetar móvel a la línea y tierra y por lo tanto dañar ellos.
- 1 – Read the entire manual carefully before starting the furniture assembly.
- 2 – The assembly must be done on a flat and clean surface.
- 3 – It is recommended to use the packaging of the furniture to cover and floor and thus not to damage them.

LIMPEZA E CONSERVAÇÃO / LIMPIEZA Y CONSERVACIÓN / CLEANLINESS AND CONSERVATION:

A limpeza do móvel deve ser feita com utilização de pano umedecido com água, podendo conter uma pequena quantidade de álcool. Não utilize produtos abrasivos.

La unidad de limpieza se debe realizar con el uso de paño humedecido con agua y puede contener una pequeña cantidad de alcohol. No utilice productos abrasivos.

The furniture should be cleaned with a cloth dampened with water and may contain a small amount of alcohol. Do not use abrasive products.

GARANTIA / GARANTÍA / WARRANTY:

90 dias para defeitos de fabricação.

90 días a defectos de fabricación.

90 days for manufacturing defects.

FERRAMENTAS NECESSÁRIAS / HERRAMIENTAS NECESARIAS / TOOLS REQUIRED:

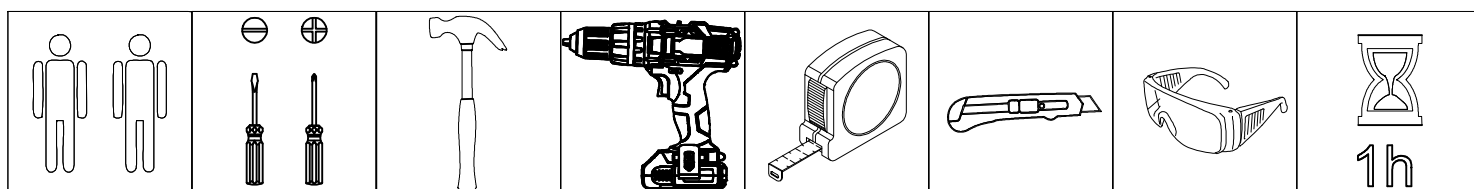

Acesse as dicas de
montagem no Youtube

Accede a los consejos de
montaje en Youtube.

Access the mounting tips on
Youtube.









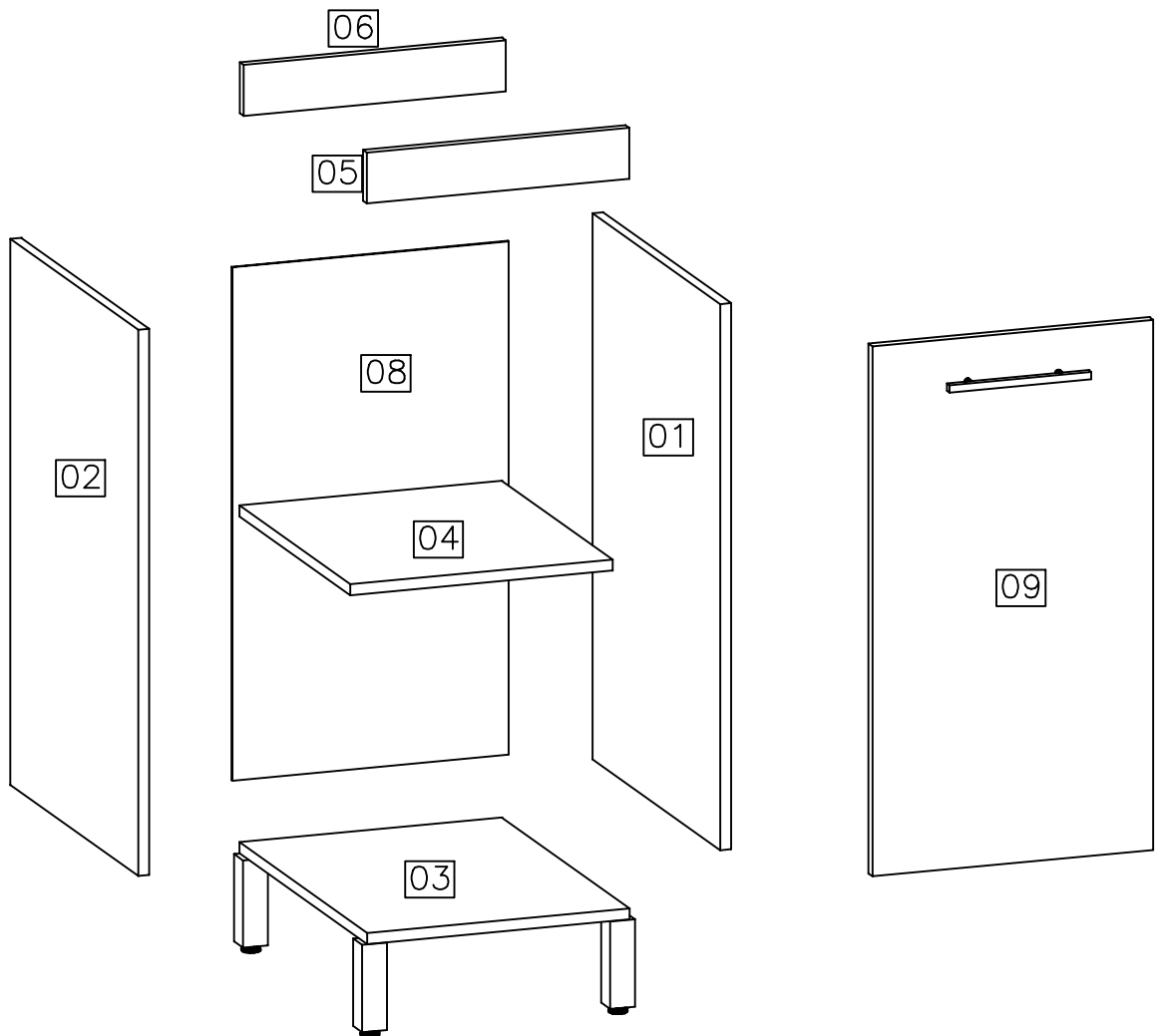

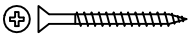

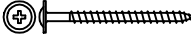
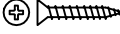

www.youtube.com/MoveisKappesberg

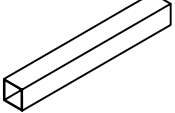
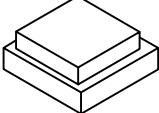

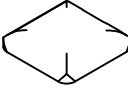
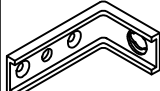
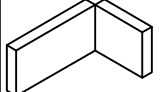
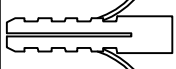
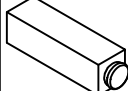
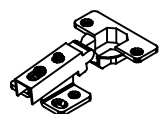
Lista de peças / Lista de piezas / List of pieces

Código/ Código/ Code	Descrição	Descripción	Description	Quantidade/ Cantidad/ Amount	Comprimento/ Longitud/ Length (mm)	Largura/ Ancho/ Width (mm)	Espessura/ Espesor/ Thickness (mm)	Caixa/ Caja/ Box
01	Lateral direita	Lateral derecha	Right side	1	750	496	15	A
02	Lateral esquerda	Lateral izquierda	Left side	1	750	496	15	A
03	Base	Pieza de suelo	Base	1	370	496	15	A
04	Prateleira	Estanterías	Shelf	1	370	430	15	A
05	Travessa frontal	Travesaño delantero	Front cross-piece	1	370	70	15	A
06	Travessa traseira	Travesaño trasero	Cross-back piece	1	370	70	15	A
07	Sarrafo de apoio	Marco de apoyo	Support slat	1	390	50	15	A
08	Costa	Pieza del fondo	Back panel	1	705	390	3	A
09	Porta	Puerta	Door	1	728	396	15	A

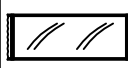
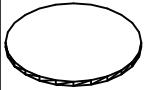

Ferragem / Herrajes / Hardware			
Código/ Código/ Code	Descrição / Descripción / Description	Quan. / Cant./ Amou.	
A 226	 Parafuso/ Tornillo/ Screw 4x40	11	
B 4214	 Parafuso/ Tornillo/ Screw 3,5x14	12	
C 50311	 Parafuso/ Tornillo/ Screw 5,0x65	8	
D 491	 Parafuso/ Tornillo/ Screw 4x25	4	
E 107	 Prego/Clavo/Nail 10x10	22	
F 1802	 Cavilha/Tarugo/Peg 6x30mm	8	
G 45100	 Parafuso maquina/ Tornillo/ Screw M4x40	2	
H 51435	 Puxador de metal/Asar/Handle 10x10 Champagne 200mm	1	
I 44721	 Ponteira/Puntera del asar/Handle pointer 10x10 champagne fosco (Par)	1	
J 44723	 Afastador de nylon/Separador del asar/Handle retractor 20mm Champagne (Par)	1	
K 40534	 Silicone/Silicona/ Selecone 10x10	2	
L 17024	 Suporte aéreo zb/Suporte de seguridad/Safety bracket	2	
M 6959	 Capa para suporte branca/Cubierta de soporte/Support cover	2	
N 529	 Bucha invasiva/Adapter sleeve/ Manga del adaptador	4	
O 51433	 Pézinho apolo/Perrito/Foot counter Champagne	4	
P 51322	 Dobradiça reta 35mm calço fixo com amortecedor/Bisagra/h inge	2	
Q 1828	 Parafuso/ Tornillo/ Screw 3,5X14	8	
R 118	 Suporte para prateleira/Suporte de estante/Shelf support	6	
S 58	 Etiqueta marca/Tag label "Kappesberg"	1	
T 41	 Cola branca em bisnaga/Cola blanca/White glue (10g)	1	
U	 Tapa furo/Tapa del agujero/Tap hole 13mm	12	FRCH =51255 (Freijo)
V 85	 "L" de metal/Cantón "L" de metal/Metal angle bracket "L"	4	
01 Saco pequeno para acessórios			



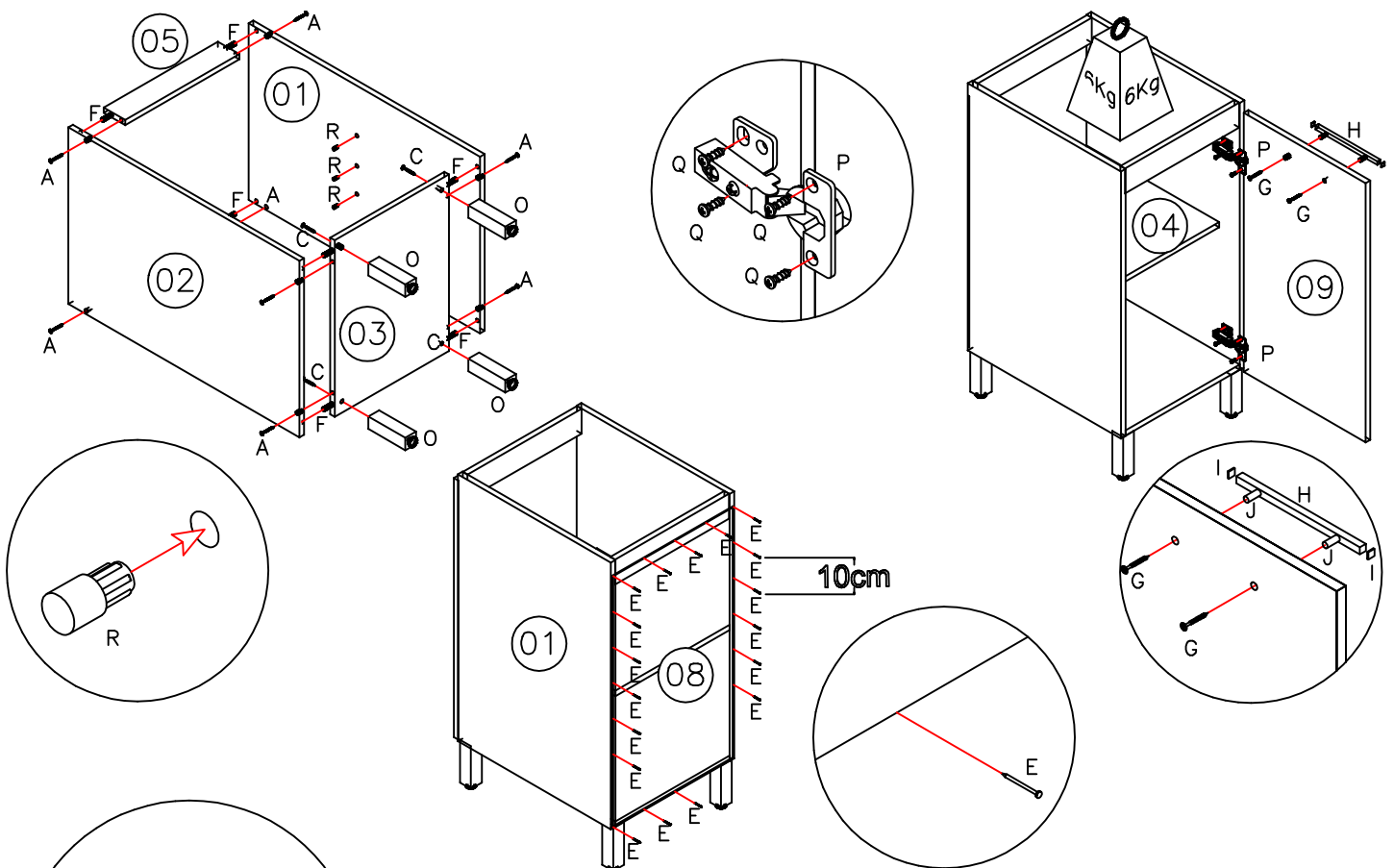

Para montar a cozinha suspensa:

- Utilize o sarrafo de apoio (07) que acompanha o móvel como apoio para sua fixação na parede, utilizando a bucha "N" e o parafuso "C".
- Em uma lateral fixe um suporte aéreo metalizado "L" com o parafuso "B" e na parede com o parafuso "C" e com a bucha "N".
- Coloque uma capa "M" em cada suporte "L".

Para montar la cocina suspendida:

- Use el marco de apoyo (07) que viene con los muebles como soporte para su montaje en la pared utilizando el casquillo "N" y el tornillo "C".
- Por un lado, fije un soporte neumático metálico "L" con el tornillo "B" y la pared con el tornillo "C" y el casquillo "N".
- Coloque una cubierta "M" en cada soporte "L".

To mount the kitchen suspended:

- Use the support slat (07) board that comes with the furniture as a support for its wall mounting using the "N" bush and the "C" screw.
- On one side, fix a metallic air support "L" with the screw "B" and the wall with the screw "C" and the bushing "N".
- Place a "M" cover on each "L" bracket.

