

ME - 4130

Instruções de Montagem Assembly Instructions Instrucciones de Montaje

Acesse Vídeos de Montagens
Access Mounting Videos
Acceder a los Vídeos de Montaje
www.tecnomobili.ind.br

tecnomobili

Estrada RSC 453, Km s/n° | Garibaldi | RS
CEP: 95720-000 | Fone / Fax: 54.3464.2050
sac@moveisvideira.com.br

Notas Especiais:

01 -Examine completamente todas as peças do móvel antes de começar o trabalho.

02 -Recomenda-se montar o móvel conforme este Manual de Montagem.

03 -É de responsabilidade do montador seguir as instruções do Manual de Montagem, que são fundamentais para garantir a estrutura do móvel.

04 -Para limpeza, utilizar somente pano úmido e sabão neutro.

Special notes:

01 -Check all parts of the unit thoroughly before starting work.

02 -It is recommended to assemble the furniture according to this Installation Manual.

03 -It is the responsibility of the assembler to follow the instructions in the Assembly Manual, which are essential to ensure the structure of the furniture.

04 -For cleaning use only damp cloth and neutral soap.

Notas especiales:

01 -Examine completamente todas las piezas del mueble antes de iniciar el trabajo.

02 -Se recomienda montar el mueble conforme el Manual de Ensamblaje.

03 -Es de responsabilidad del montador seguir las instrucciones del Manual de Ensamblaje, que son fundamentales para garantizar la estructura del mueble.

04 -Para limpieza solamente usar trapo húmedo y jabón neutro.

Guarante certificate:

The guarantee of products manufactured by Móveis Videira LTDA covers any defects / manufacturing defects, within the period established by the Consumer Protection Code, in its Article 26, II, which provides for a legal guarantee of ninety (90) days.











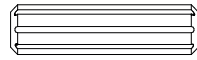
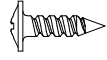

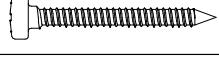
Lista de Peças / List of pieces / Lista de piezas

CóD	DESCRIÇÃO	DESCRIPTION	DESCRIPCIÓN	QTD	RAW MATERIAL	DIMENSION
01	Tampo	Top	Tapa	1	MDP 15mm	1358x450x15
02	Lateral	Side	Lateral	1	MDP 15mm	725x450x15
03	Divisão	Division	División	1	MDP 15mm	472x450x15
04	Lateral Gaveteiro	Drawer Side	Lateral Cajón	1	MDP 15mm	725x450x15
05	Rodapé	Baseboard	Rodapié	1	MDP 15mm	320x70x15
06	Costa Maior	Larger Back	Revés Major	1	MDP 15mm	1327x238x15
07	Costa Menor	Smaller Back	Revés Menor	1	MDP 15mm	482x340x3
08	Frente Gaveta	Drawer Front	Frente Cajón	2	MDP 15mm	204x300x15
09	Lateral Gaveta	Drawer Side	Lateral Cajón	4	MDP 15mm	300x140x15
10	Costa Gaveta	Drawer Back	Revés Cajón	2	MDP 15mm	140x263x15
11	Fundo Gaveta	Drawer Bottom	Fondo Cajón	2	Chapa Dura 3mm	309x242x3
12	Travessa	Traverse	Traviesa	1	MDP 15mm	1358x45x15
13	Travessa Direita	Right Traverse	Traviesa Derecha	1	MDP 15mm	741x45x15
14	Travessa Esquerda	Left Traverse	Traviesa Izquierda	1	MDP 15mm	741x45x15
15	Tampo Gaveta	Drawer Top	Tapa Cajón	1	MDP 15mm	335x450x15

REF

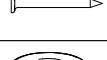
DESCRIÇÃO

QTD

A	 Cavilha 8 x 30mm	10
B	 3,5 x 14mm CF	28
C	 4,0 x 16mm CC	16
D	 3,5 x 30mm CP	02
E	 34 x 7mm Parafuso Minifix	24
F	 15 x 12mm Tambor Minifix	24
G	 7 x 5 x 14mm Malhete	04
H	 22 x 17 x 12mm Suporte Angular	10
I	 3,5 x 40mm CC	01
J	 32 x 45 x 20mm Distanciador de Correção	04
K	 22 x 3mm Pregos 10 x 10	20
L	 14 x 4mm Sapata Deslizadora	06
M	 Correção 350mm	02
N	 40 x 20 x 21mm Puxador	02
O	 Adesivo Tapa-Furo	04

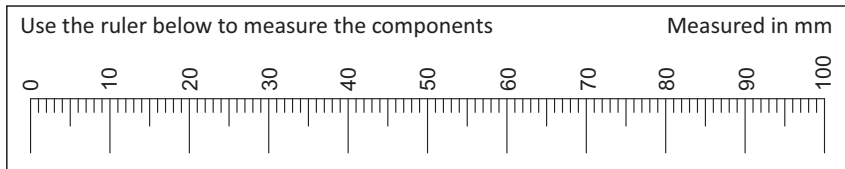
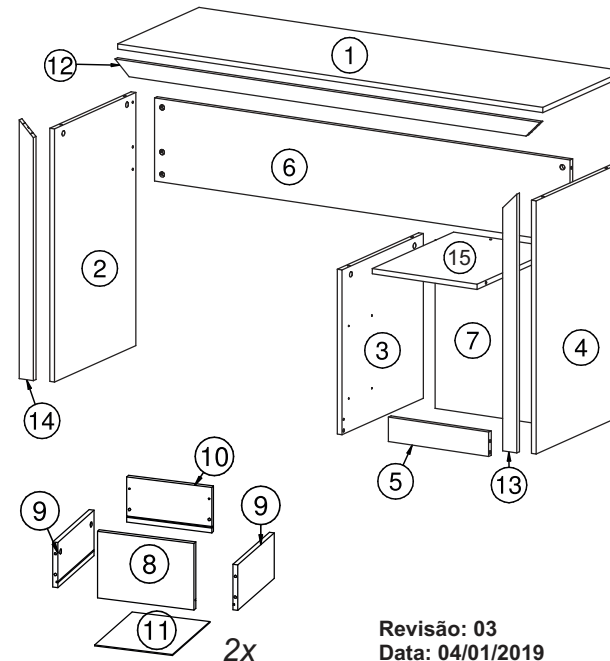

Ferramentas | Tools | Herramientas

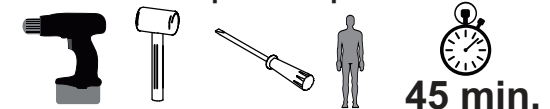

Revisão: 03
Data: 04/01/2019

