



Obs: Usar caixa da embalagem para forrar o chão na hora da montagem.  
 Note: Use the packing box to cover the floor at the time of assembly.  
 Nota: Utilice la caja de embalaje para cubrir el suelo en el momento del montaje.

COLIBRI - IND. COM. DE MÓVEIS LTDA.  
 Rua Rouxinol, 5530 - Fone/Fax: (43) 3275 - 8600  
 Pq. Industrial XI - CEP 86.706-410 - Araçatunga - PR  
 E-mail: sac@colibrimoveis.com.br  
 Site: www.colibrimoveis.com.br



Cód.	Referência	Natura R / OHW	Cor	Peças	Qt.	Medidas	M. p.	Piece	Pieza
01	1624A0.001		690	Prateleira	1	1780x160x25	MDP Shelf		Estante
02	1624A0.002		700	Tempo	1	1780x320x25	MDP Cover		Cubierta
03	1624A0.003		700	Prateleira menor	1	698x278x15	MDP Smaller shelf		Estante pequeno
04	1624A0.004		700	Base	1	1780x300x15	MDP Base		Base
05	1624A0.005		700	Panel superior	1	1800x540x15	MDP Top panel		Panel mayor
06	1624A0.006		700	Panel central	1	1800x540x15	MDP Central panel		Panel central
07	1624A0.007		700	Panel inferior	1	1800x540x15	MDP Lower panel		Panel por debajo
08	1624A0.008		690	Vista	3	955x70x15	MDP View		Vista
09	1624A0.009		690	Porta esquerda	1	545x243x15	MDP Left door		Puerta izquierda
10	1624A0.010		690	Porta direita	1	545x243x15	MDP Right door		Puerta derecha
11	1624A0.011		690	Lateral esquerda	1	300x240x15	MDP Left side		Lateral izquierda
12	1624A0.012		690	Divisão esquerda	1	300x240x15	MDP Left division		División izquierda
13	1624A0.013		690	Divisão direita	1	300x240x15	MDP Right division		División derecha
14	1624A0.014		690	Lateral direita	1	300x240x15	MDP Right side		Lateral derecha
15	1624A0.015		700	Travessa lateral maior	2	1130x70x15	MDP Largest side crossbar		Travesaño lateral mayor
16	1624A0.016		700	Travessa lateral menor	2	490x70x15	MDP Minor side guard		Travesaño lateral menor
17	1624A0.017		99	Travessa	4	1100x80x15	MDP Travessa		Travesaño
18	1624A0.018		99	Travessa central	1	400x70x15	MDP Central beam		Travesaño central

Para pedidos de Assistência Técnica, agrupar a Referência da Peça com o nº da Cor. Ex: 1624A0.001.690 (Prateleira na cor Off White)

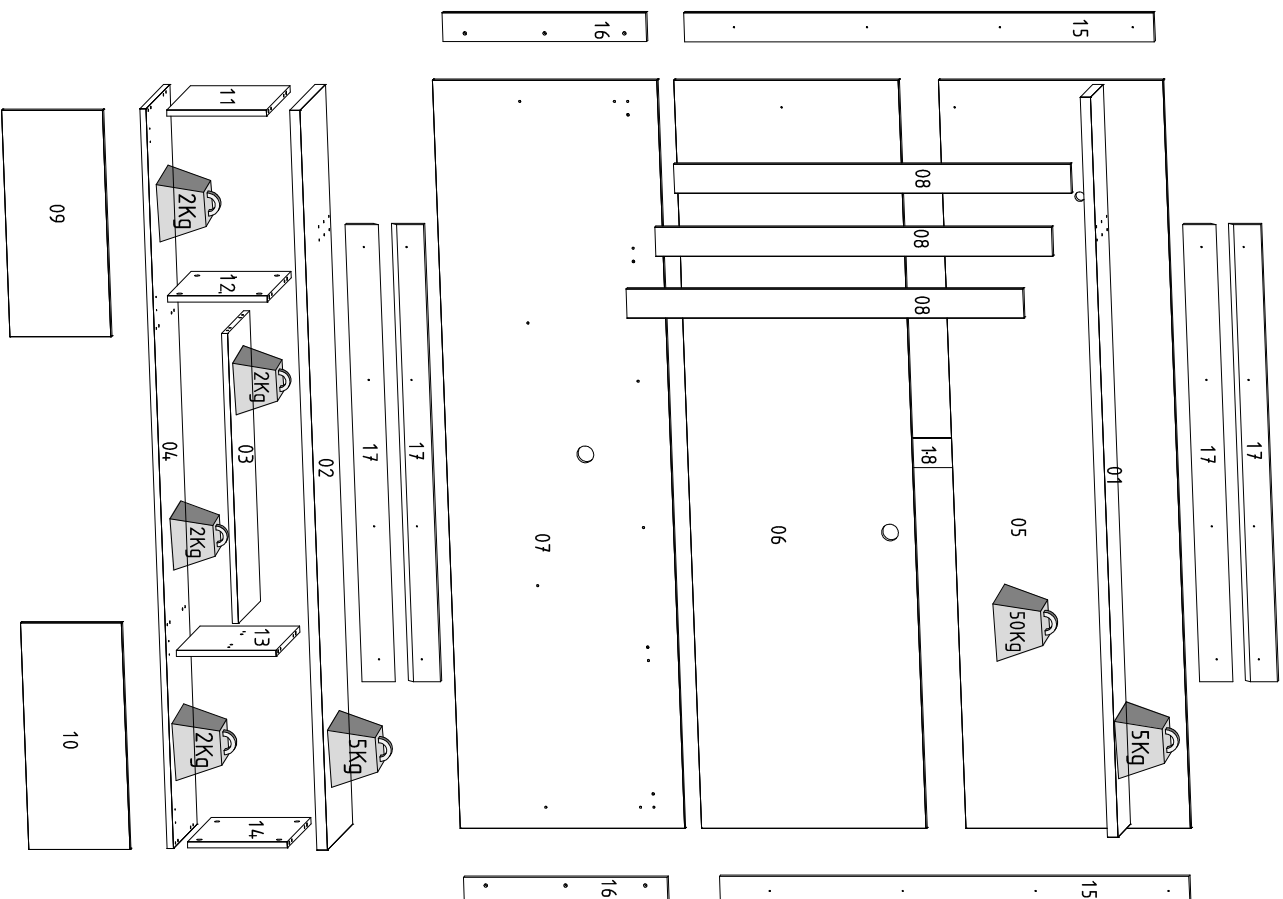

A		Parafuso 3,5 x 14 / Screw 3,5 x 14 - 40							
B		Parafuso 4,0 x 25 / Screw 4,0 x 25 / Tornillo 4,0 x 25 - 15							
C		Parafuso 4,0 x 50 / Screw 4,0 x 50 / Tornillo 4,0 x 50 - 20							
D		Parafuso 5,0 x 70mm / Screw 5,0 x 70mm / Tornillo 5,0 x 70mm - 18							
E		Cavilha 6 x 30 / Dowel Pin 6 x 30 / Cebija 6 x 30 - 28							
F		Porca cilíndrica / Cylindrical nut / Tuerca cilíndrica - 24							
G		Parafuso 3,5 x 14 / Screw 3,5 x 14 - 40							
H		Support shelf / Support estante - 04							
I		Bucha fixação Ø8 / Fixing bushing / Buje de fijación - 08							
J		Calço 5mm dobr / Shim 5mm dobr / Calce 5mm bisagra - 04							
K		Dobradilha curva 28 mm / Hinge curve 28 mm / Curva de bisagra 28mm - 04							
L		Passa fio 40mm / Pass wire 40mm / Passar cable 40mm - 02							
M		Prateleira de vidro / Glass shelf / Repisa de vidro - 02							
N		Colar Glue / Pegamento - 01							
O		Parafuso 4,5 x 60 / Screw 4,5 x 60 / Tornillo 4,5 x 60 - 12							
P		Luminaria / Luminaria - 01							
Q		Chapa reta 4 furos / Straight plate 4 holes / Pisca recta 4 agujero - 06							

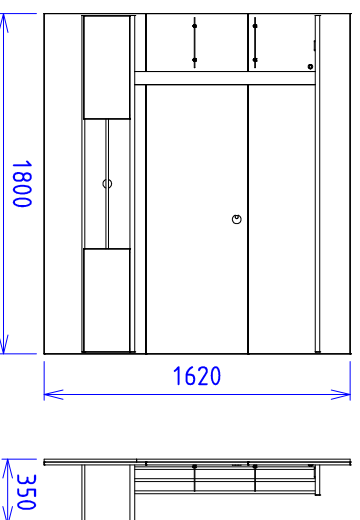

Produto montado - Comp: 1800mm / prof: 350mm / alt: 1620mm

# ETAPAS DA MONTAGEM / STAGES OF THE ASSEMBLY / ETAPAS DE LA ASAMBLEA

Para uma montagem perfeita do produto, siga a sequência:

For a perfect assembly of the product, it follows the sequence / Para un montaje perfecto del producto, sigue el secuencia

**Passo 01**  
COLOCAR BUCHA DE FIXAÇÃO "I" NA PAREDE

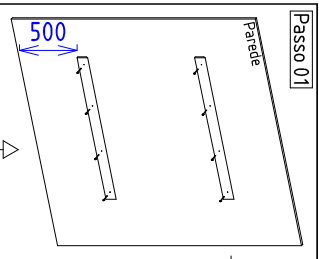

SUGESTÃO DE ALTURA DO PISO À PARTE INFERIOR DA TRAVESSA 17

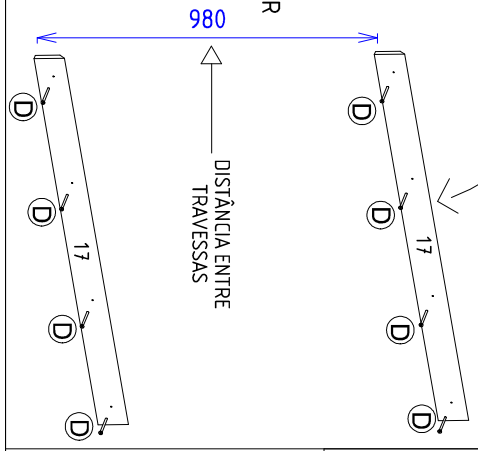

**Passo 02**

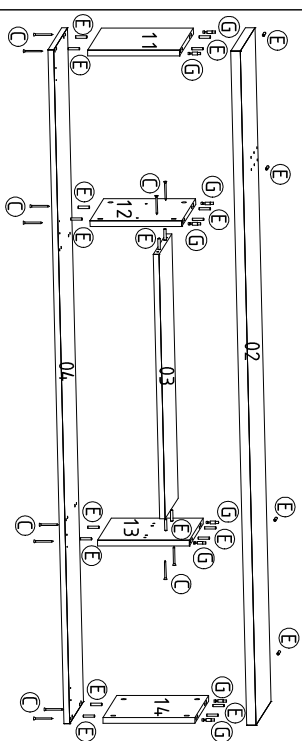

**Passo 03** Vista Traseira

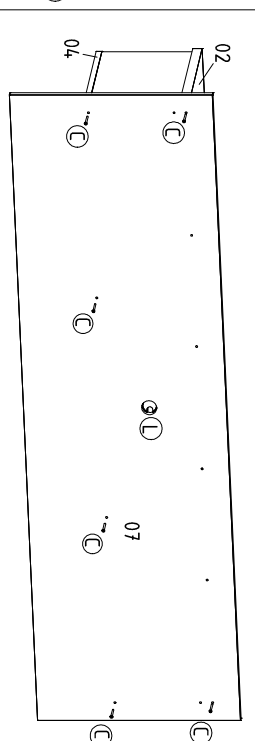

**Passo 04** Vista Traseira

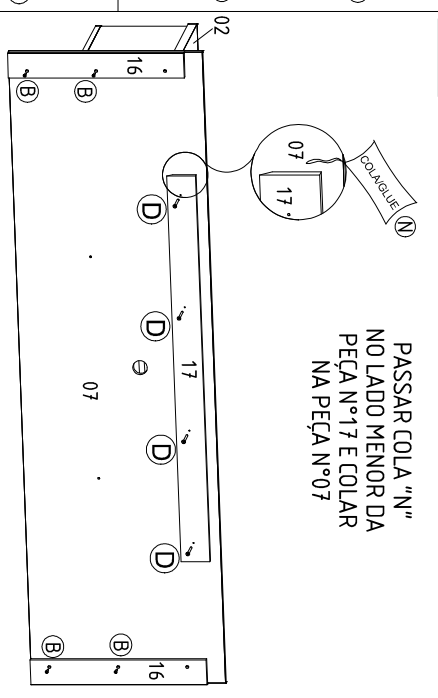

PASSAR COLA "N" NO LADO MENOR DA PEÇA N°17 E COLAR NA PEÇA N°07

OBS: OS PARAF "D" IRÃO FIXAR AS PEÇAS 02,17 E 07 JUNTAS, SEGUIR FUROS PARA FIXAÇÃO DA TRAVESSA.

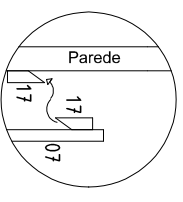

**Passo 05**

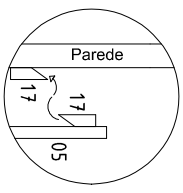
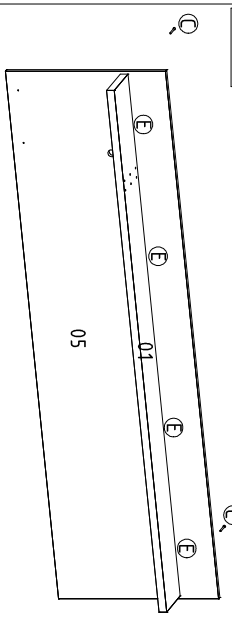

Vista Traseira

**Passo 06**

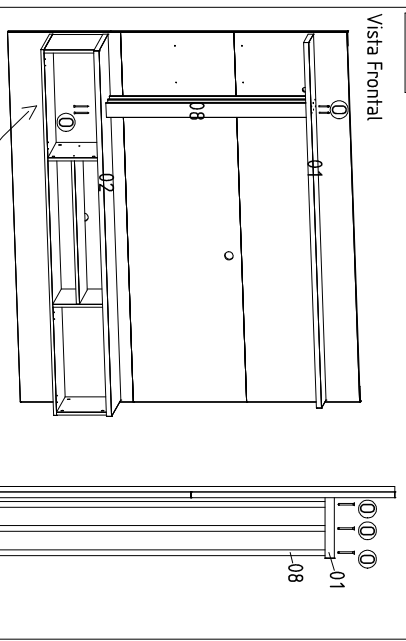

Vista Frontal

Vista lateral

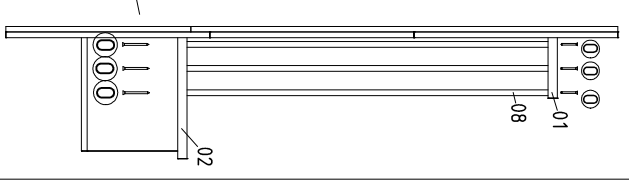

FIXAR PEÇAS 08 COM O PARAF "O" 4,5X60 (3X)

**Passo 07**

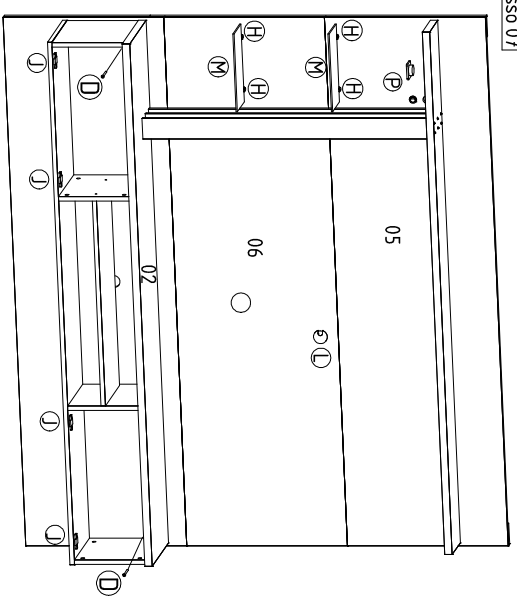

PASSAR COLA "N" NO LADO MENOR DA PEÇA N°17 E COLAR NA PEÇA N°05

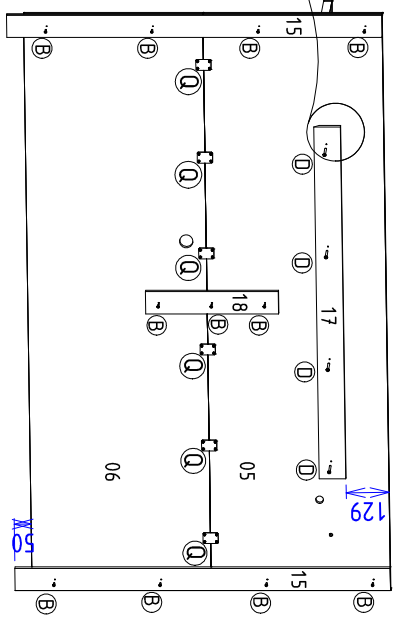

Porta Direita 10

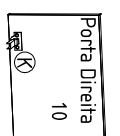

Porta Esquerda 09

