

Linha: Sala

Mod.: Home Suspense

Cód.: 1.622

Canal do Montador
 Acesso e Participar!

ESQUEMA DE MONTAGEM
ASSEMBLY INSTRUCTIONS
ESQUEMA DE MONTAJE

Obs: Usar caixa de embalagem para forrar o chão na hora da montagem.
 Note: Use the packing box to cover the floor at the time of assembly.
 Nota: Utilice la caja de embalaje para cubrir el suelo en el momento del montaje.

COLIBRI - IND. COM. DE MÓVEIS LTDA.
 Rua Rouxinol, 5530 - Fone/Fax (43) 3275 - 8600
 Pq. Industrial XI - CEP 86.706-410 - Araucarias - PR
 E-mail: sac@colibrimoveis.com.br
 Site: www.colibrimoveis.com.br



Cód.	Referência	Cor	Pegas	Qt.	Medidas	M.p.	Piece	Pieza
01	1622A0.001	690 Off-white	Pareleira	1	995x150x25	MDP	Shelf	Estante
02	1622A0.002	690	Tampo	1	1590x296x25	MDP	Cover	Cubierta
03	1622A0.003	690	Base	1	1590x296x25	MDP	Base	Base
04	1622A0.004	460	Panel Sup	1	1600x540x15	MDP	Panel Sup	Panel de control
05	1622A0.005	460	Panel Cent	1	1600x540x15	MDP	Cent Panel	Panel Cent
06	1622A0.006	460	Panel Inf	1	1600x540x15	MDP	Inf Panel	Panel Inf.
07	1622A0.007	690	Panel Sup Frontal	1	932x395x15	MDP	Front Panel Sup	Panel Frontal
08	1622A0.008	690	Panel Cent Frontal	1	395x198x15	MDP	Cent Head Panel	Panel Cent Frontal
09	1622A0.009	690	Panel Inf Frontal	1	395x238x15	MDP	Front Inf Panel	Panel Inf Frontal
10	1622A0.010	690	Porta	1	572x196x15	MDP	Door	puerta
11	1622A0.011	690	Lateral Esq	1	294x200x25	MDP	Lateral Left	Lateral Esq
12	1622A0.012	690	Lateral Dir	1	294x200x25	MDP	Lateral Say	Lateral Dir
13	1622A0.013	690	Divisão Esq	1	276x200x15	MDP	Left Division	División Esq
14	1622A0.014	690	Divisão Dir	1	276x200x15	MDP	Dir Division	División Dir
15	1622A0.015	460	Travessa Lat Maior	2	1130x70x15	MDP	Lat Greater Travessa	Travessa Lat Mayor
16	1622A0.016	460	Travessa Lat Menor	2	488x70x15	MDP	Lat Minor Travessa	Travessa Lat Menor
17	1622A0.017	99	Travessa Central	1	500x70x15	MDP	Central Travessa	Travessa Central
18	1622A0.018	99	Travessa Panel Sup	1	900x80x15	MDP	Travessa Panel Sup	Travessa Panel Sup
19	1622A0.019	99	Travessa Panel Inf/Parede	3	900x80x15	MDP	Travessa Inf / Wall Panel	Trampa Panel Inf / Pared

Para pedidos de Assistência Técnica, agrupar a Referência da Peça com o nº da Cor. Ex: 1621A0.001,460 (Preteleira na cor Canela Rústico)

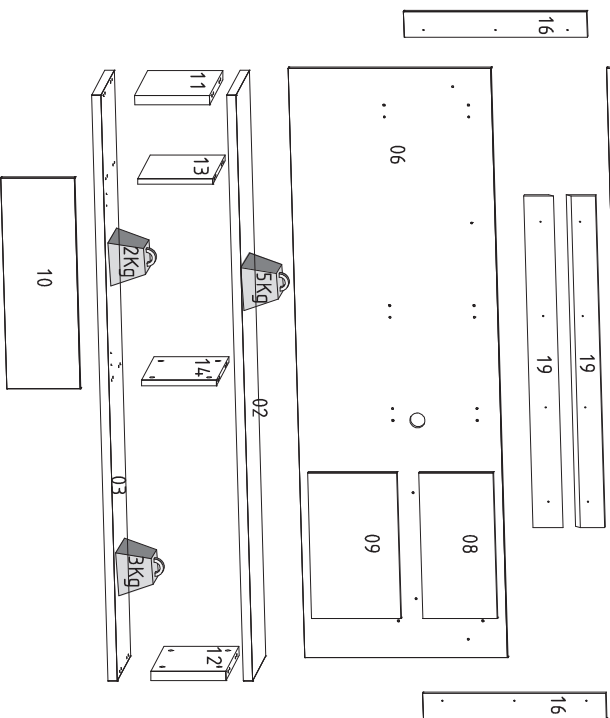

A	B	C	D	E	F
Parafuso 3,5 x 14 / Screw 3,5 x 14 / Tornillo 3,5 x 14 - 28	Parafuso 4,0 x 25 Screw 4,0 x 25 Tornillo 4,0 x 25 - 42	Parafuso 5,0 x 50mm / Screw 5,0 x 50mm / Tornillo 5,0 x 50mm - 3	Parafuso 5,0 x 70mm / Screw 5,0 x 70mm / Tornillo 5,0 x 70mm - 28	Cavilha 6,3 x 30 / Dowel Pin 6,3 x 30 / Clavija 6,3 x 30 - 26	Taper/tambor/pino Lid/Drum/Pin Tapal/tambor/pino - 19/8/8
Porca cilíndrica Cylindrical nut / Tuercas cilíndricas - 08	Bucha fixação 08 / Fixing Bushing / Bujes de fijación - 10	Colar/clip / Repagamento - 01	Calco 12mm Shim 12mm Calca 12mm - 02	Dobradilha curva 28 mm Impe curve 28 mm Caixa de bisagra 28mm - 02	Passa fio 40mm Pass wire 40mm Pasar cable 40mm - 02
Luminaria Luminaire - 01	Supporte Vidro Supporte Glass/ Supporte vitrino - 04	Pareleira de vidro Glass shelf Reparsi de vidro - 02	Chapa retã 4 furos Slitgrit plate 4 holes Placa recta 4 agujero - 04	Cavilha 6 x 20 / Dowel Pin 6,3 x 20 / Clavija 6 x 20 - 06	

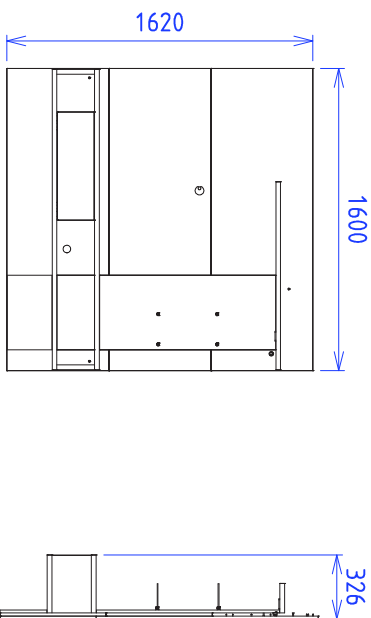

Produto montado - Comp: 1600mm / prof: 326mm / alt: 1620mm

ETAPAS DA MONTAGEM / STAGES OF THE ASSEMBLY / ETAPAS DE LA ASAMBLEA

Para uma montagem perfeita do produto, siga a sequência:

For a perfect assembly of the product, it follows the sequence / Para un montaje perfecto del producto, sigue el secuencia

Passo 01 COLocar BUCHA DE FIXAÇÃO "H" NA PAREDE

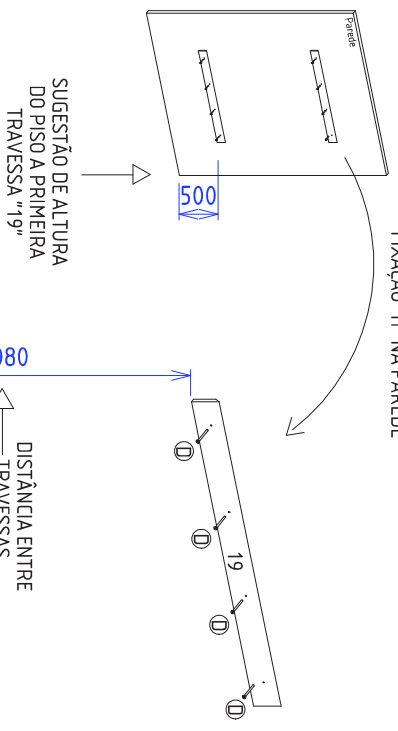

Passo 02 VISTA FRONTAL

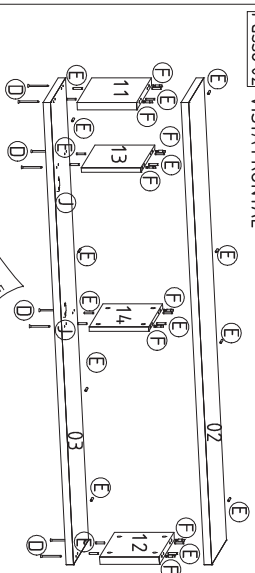

Passo 03 VISTA FRONTAL

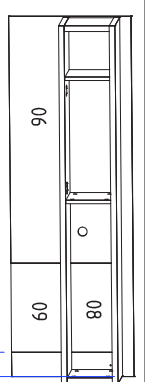

VISTA FRONTAL

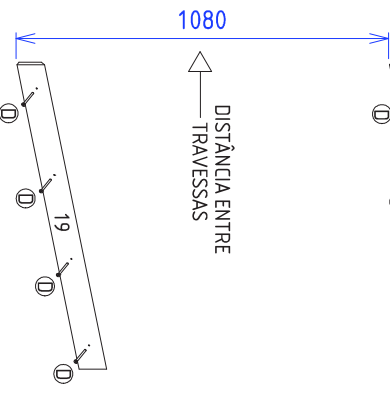

VISTA TRASEIRA

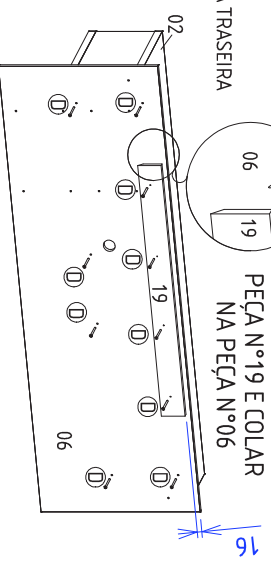

Passo 05

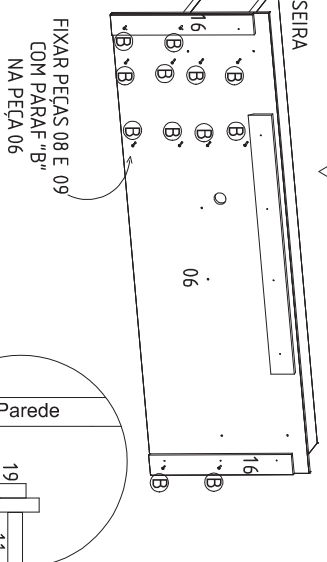

VISTA TRASEIRA

PASSAR COLA "I" NO LADO MENOR DA PÉÇA Nº18 E COLAR NA PÉÇA Nº04

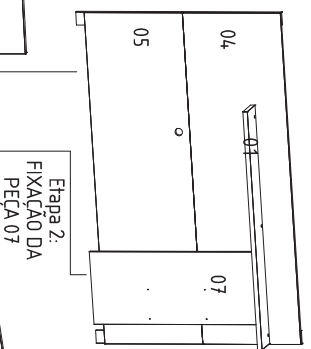
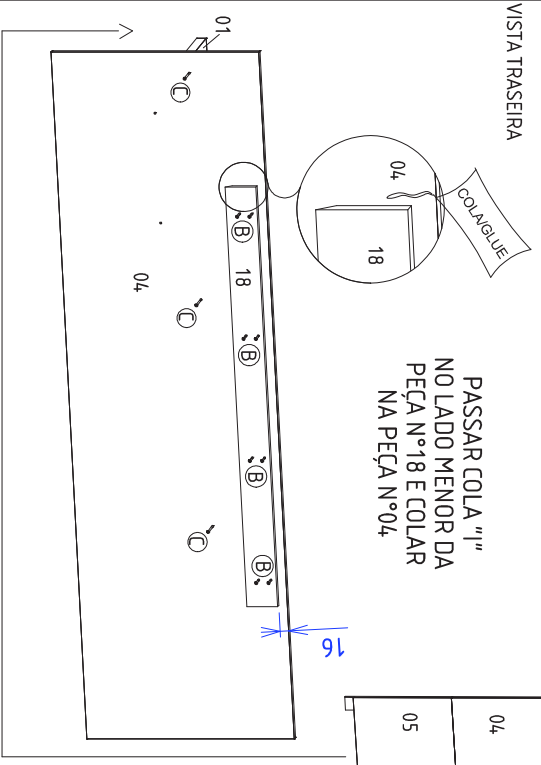

Etapa 2: FIXAÇÃO DA PÉÇA 07

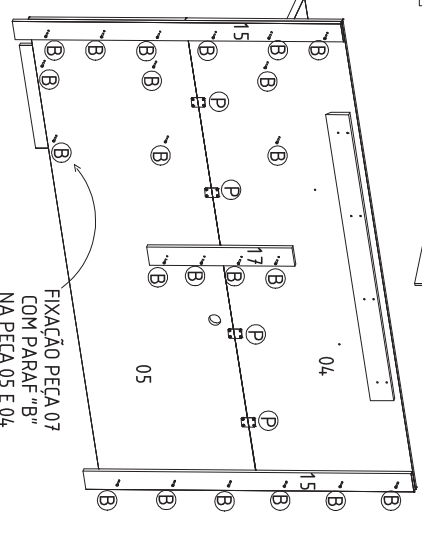

FIXAÇÃO DA PÉÇA 01

